



WHISTLER

TRAIL STANDARDS

ENVIRONMENTAL AND TECHNICAL TRAIL FEATURES



4325 BLACKCOMB WAY, WHISTLER BC CANADA V0N 1B4
TELEPHONE (604) 932-5535 FACSIMILE (604) 935-8109

www.whistler.com/rmow

RESORT MUNICIPALITY OF WHISTLER

FIRST EDITION

AUTHOR'S NOTES

As planners, we must not lose sight of the fact that guests are here to have a good time, avoid injury and not get lost.

The evolution of mountain bike trails, recreational equipment, and environmental issues require that this document be amendable.

Thanks to North Shore Mountain Bike Association (NSMBA) and the Whistler Off-Road Cycling Association (WORCA) for reviewing the document and providing feedback. Also thanks to Channa Pelpola, Ken Neave and Jim Richardson for their feedback and insight. Special thanks to Keith Bennett for his feedback, insight and proactive approach to mountain biking.

Cover photos were provided by Bonnie Makarewicz Photography and David Diplock, Director of the North Shore Mountain Bike Association. Trail Type drawings by Jensen Resort Planning.

Andrew DeBoer
Whistler Cycling Committee
Summer 2003



DAVID DIPLOCK PHOTO

TABLE OF CONTENTS

Author's Notes	1
Table of Contents	2
Introduction	3
Trails and Land Use	4
Land Use Directions	4
Compatibility Matrix	5
Trail Types	6
Mountain Bike Trail Difficulty Levels	8
Supporting Guidelines and Standards	10
Environmental Guidelines	10
TTF Construction Standards	12
Fall Zone Guidelines	14
Sign Guidelines	15
Management Guidelines	17
Trail Maintenance	17
Terminology	19



DAVID DIPLOCK PHOTO

INTRODUCTION

Whistler, British Columbia has been recognized as a premier destination resort for mountain biking. For the most part, this can be credited to the Whistler Mountain Bike Park and a network of valley and off-road trails that provide a recreational and commuter experience for a wide range of residents and visitors. To sustain this experience, the Resort Municipality of Whistler (RMOW) proposes to review, sign, maintain and manage this network of trails throughout the Whistler Valley. This document is not a “how-to” on building or maintaining trails; rather it is the standard by which the trails will be managed within the Whistler Valley.

The Resort Municipality of Whistler’s Trail Standards, Environmental and Technical Trail Features was drafted in support of two initiatives identified by Volume One of Whistler 2002: Charting a Course for the Future. The first and foremost initiative described under the priority of Moving Toward Environmental Sustainability, states “We’ve established a trail hierarchy and environmental standards to ensure the type of trail and its maintenance is appropriate to the setting.” A land use compatibility matrix was developed to address this objective. The matrix outlines the Trail Type and Trail Difficulty Level acceptable in distinct land-use classes. As well, environmental guidelines were established to minimize the placement of trails in sensitive environments. The second initiative described under the priority of Enhancing the Whistler Experience states “Whistler is one of the top bike towns in North America, with world-class trails...” Whistler’s trails must continue to provide exciting experiences for all levels of riders from families to advanced riders. Attention to providing a challenging experience, maintenance, a seamless network and an easy-to-use trail system will help position Whistler as one of the top bike towns in North America.

Appropriate management of our on- and off-road trail network is intended to elevate Whistler’s status as a cycling destination with minimal environmental impact.



BONNIE MAKAREWICZ PHOTO

TRAILS AND LAND USE

This section is a macroscopic view of the trails, the environment and where trails may be placed. This section outlines the levels of land protection, trail type descriptions and trail difficulty levels. These three classifications interact together as defined by a compatibility matrix.

LAND USE DIRECTIONS

Whistler’s environmental values and principles direct us to address land use as an important environmental consideration. Whistler’s principle of an ecosystem-based approach advises us to mesh our human purposes with the larger patterns and flows of the natural world, and to study these to inform and guide our activities on the land.¹

From the draft Whistler Environmental Strategy, six land use directions are defined for the Whistler Valley. Each land use direction has a different level of environmental protection. For the purpose of this document, the LRUP and PAN 3 are given the same level of conservation.

DEVELOPED AREAS – This land use designation includes industrial, commercial and residential areas.

RECREATIONAL GREENWAYS – An important means for creating linkages between the built and natural environments, and between the needs of human communities and natural ecological systems. Incorporating opportunities for both recreational activities and the maintenance of natural features and wildlife habitat, Recreational Greenways are a vital part of environmentally responsible land use planning.²

LRUP – The Local Resource Use Plan was developed in response to public concerns over logging effects on the visual quality of landscapes and the recreation uses of the land in and near the RMOW. It was a joint effort from the Ministry of Forests, Squamish Forest District, and the RMOW.³ The LRUP boundaries extend from Brandywine Falls in the south to Cougar Mountain in the north. LRUP land contains rare and unique species or unique habitat features not found in other ecosystems and are therefore important to protect.⁴

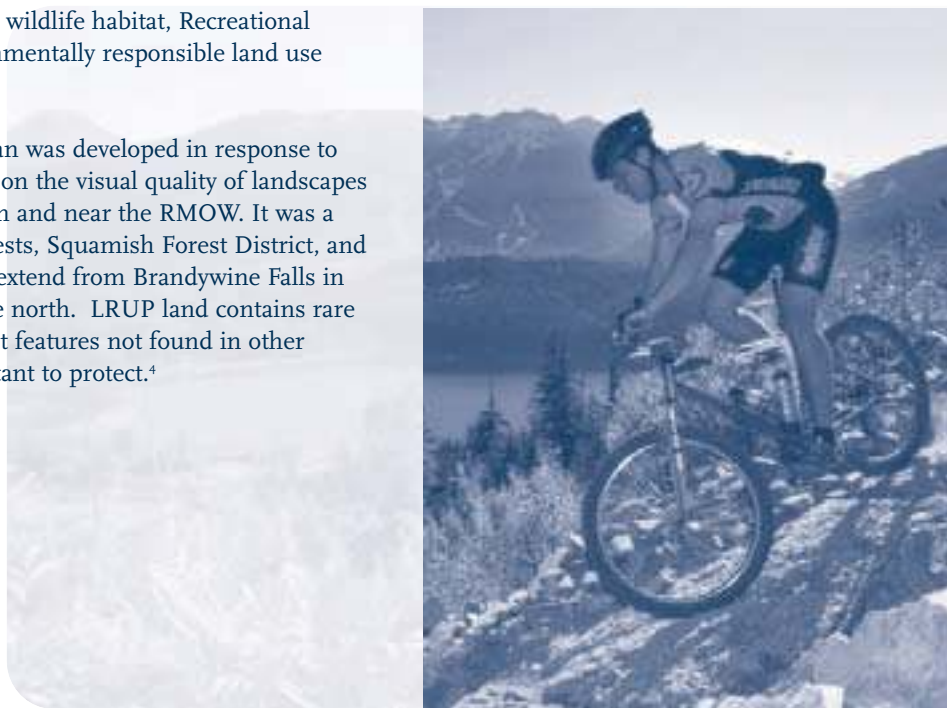

BONNIE MAKAREWICZ PHOTO

¹The Whistler Environmental Strategy, Discussion Paper, September 21, 1999, Executive Summary, Page x.
²Ibid., Section 6.0, Page 35.
³Forest Recreation Plan, Whistler Local Resource Use Plan, June, 1995, Page 1
⁴The Whistler Environmental Strategy, Section 4.0, Page 23.

PAN PROTECTED AREA NETWORK – Divided into the following three subcategories of protection.⁵

PAN 3 – RESERVE LANDS Large tracts of relatively natural land, which could be subject to recreational or other development provided an Environmental Impact Assessment is done. PAN 3 protection is generally used for second growth forests and other natural areas not include in PAN 1 and 2. In cases of development, key ecological components of reserve lands may be subject to PAN 1 or 2 protection after development. Most trail types are acceptable with the exception of paved Type I trails.

PAN 2 – SPECIAL MANAGEMENT ZONES Well protected and allow some low-impact human activities or development (creation of trails). Priorities for PAN 2 protection include significant streams and riparian areas, significant old growth forests and wildlife corridors. Only low impact trails such as Trail Type III, IV or V are acceptable to be built in PAN 2 areas.

PAN 1 – KEY PROTECTED AREAS Preserved to protect unique and sensitive ecosystems from any human development or use, with the possible exception in individual cases of very low-impact nature trails, boardwalks or wildlife viewing platforms for the specific purpose of habitat protection. Priorities for PAN 1 protection include streams, wetlands, riparian areas, old growth forests, key wildlife corridors and unique or threatened habitat types. No cycling trails are to be built in these areas.

COMPATIBILITY MATRIX

The Whistler Valley effectively has five land use directions. These land use directions relate to the five trail types (reference to page 6-7) and the first four trail difficulty levels (reference to page 8-9) in the following compatibility matrix. The RMOW will construct new trails only in environments compatible with trails.

		LAND USE DIRECTION																		
		Developed Areas		Greenways		PAN 3 include LRUP		PAN 2		PAN 1										
Mountain Bike TRAIL DIFFICULTY		⊖	⊖	⊖	⊖	⊖	⊖	⊖	⊖	⊖	⊖	⊖	⊖	⊖	⊖	⊖	⊖	⊖	⊖	⊖
TRAIL TYPE	I	✓	x	x	x	✓	x	x	x	x	x	x	x	x	x	x	x	x	x	x
	II	✓	✓	✓	x	✓	✓	✓	x	x	✓	✓	x	x	x	x	x	x	x	x
	III	x	✓	✓	✓	x	✓	✓	✓	x	✓	✓	✓	x	✓	✓	✓	x	x	x
	IV	x	x	✓	✓	x	x	✓	✓	x	x	✓	✓	x	x	✓	✓	x	x	G G
	V	x	x	x	✓	x	x	x	✓	x	x	x	✓	x	x	x	✓	x	x	✓ ⁶ ✓ ⁶

✓ = Compatible x = Incompatible G = Grandfather Clause⁷

TABLE 1 COMPATIBILITY MATRIX

⁵ The Whistler Environmental Strategy, Section 5.1, Page 29.
⁶ Only hiking trails, in individual cases, on very low-impact nature trails, boardwalks or wildlife platforms for the specific purpose of habitat protection are permitted to be constructed in PAN 1.
⁷ Refer to page 18, this document

TRAIL TYPES

Trail Types⁸ are a description of non-motorized trail tread characteristics. Trail Type I has the highest amount of traffic and the most impact on the environment of the trail types. Conversely, Trail Type V has little traffic and the trail tread is minimal.

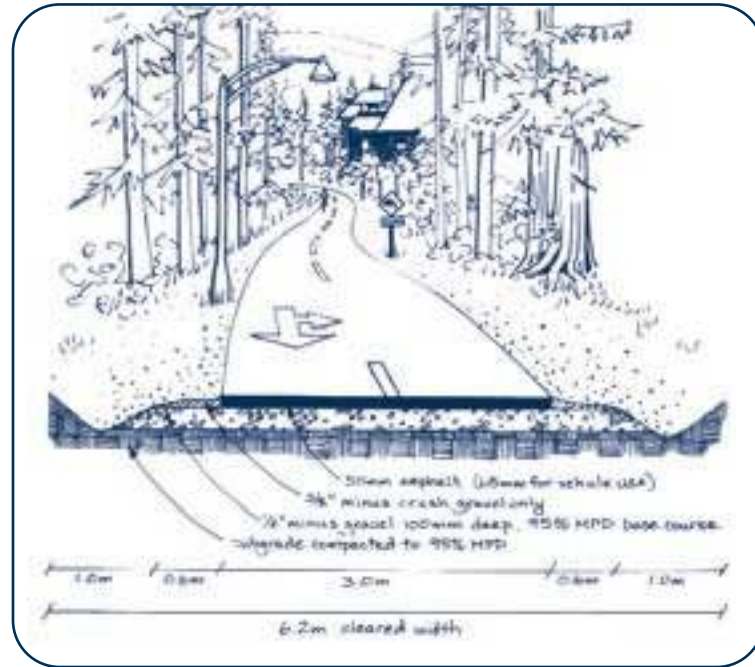

TRAIL TYPE I

TYPE I

- plan as paved double-track trail for smooth, all weather use to provide access to village, parks and subdivisions
- use asphalt or chip-seal coat surfacing
- clear width to tread width plus 0.6 m gravel shoulder and adequate drainage on each side
- clear height to 3.0 m
- provide 2-3 m tread width
- provide illumination for night use if appropriate
- provide interpretive and directional signs, benches, viewing areas where appropriate



TRAIL TYPE II

TYPE II

- plan as surfaced double-track or single-track trail
- machine built
- remove all embedded trail obstacles
- use crushed limestone with fines, well-compacted gravel, or existing old roadbeds
- clear width to 5.0 m for double-track and 1.6 m for single-track trails
- clear height to 2.4 m
- provide 2-3 m tread width for double-track trails, 1 m for single-track trails
- provide illumination for night use if appropriate

TYPE III

- plan as unsurfaced single-track trail
- may be machine built
- clear width to 1.1-1.3 m
- clear height to 2.4 m
- provide 50-70 cm tread width on native soil



TRAIL TYPE IV

TYPE V

- plan as low-impact nature trail or lightly used wilderness trail
- no high impact users, such as motorized vehicles or horses
- clear height to 2.4 m
- provide 30-50 cm tread maximum, avoid tread grubbing, sections of very rough terrain
- in the case of low-impact nature trails use boardwalks to traverse sensitive areas



TRAIL TYPE III

TYPE IV

- plan as unsurfaced single-track trail
- clear width to 1 m
- clear height to 2.4 m
- provide 30-50 cm width tread on native soil, sometimes rough terrain



TRAIL TYPE V

⁸ Sources for these classifications are: BC Parks; BC Forest Service and RMOW P-4 Risk Management, Trail Classifications, Schedule C

MOUNTAIN BIKE TRAIL DIFFICULTY LEVELS

The following identify all the levels of trail technical difficulty as they apply to mountain bikes, starting with easiest and moving up to expert unlimited. Included are general and detailed description of trails and Technical Trail Features (TTFs). This section quantifies what characteristics compose the trail difficulty for mountain bikes.



NAME: Easiest **SYMBOL:** White circle

GENERAL

- Fairly flat, wide and paved. Suitable for all users.⁹

DETAILED

- Maximum grade: 10%
- Preferred average grade: no more than 5%
- Maintain a minimum 2.5 m curve radius
- Usually associated with Trail Type I

EXPECTED TECHNICAL TRAIL FEATURES

TTFs are not appropriate for this trail level.



NAME: Easy **SYMBOL:** Green circle

GENERAL

- Gentle climbs and easily avoidable obstacles such as rocks, roots and pot-holes.¹⁰

DETAILED

- Maximum grade: 15%
- Maximum sustained climbing grade: 8%
- Curve radius: 2.4 m minimum
- Usually associated with Trail Type II or III

EXPECTED TECHNICAL TRAIL FEATURES

GENERAL

- Small roots & logs to cross
- Embedded rocks to avoid
- Wide bridges

DETAILED

- Embedded trail obstacles: up to 10 cm.
- Logs and roots perpendicular to direction of travel ($\pm 15^\circ$)
- Bridge minimum 90 cm wide, handrail required if height of bridge above surface exceeds 60 cm
- Rock face descents not to exceed 25%
- No drops
- No jumps



NAME: More Difficult **SYMBOL:** Blue Square

GENERAL

- Challenging riding with steep slopes and/or obstacles, possibly on a narrow trail with poor traction. Requires riding experience.¹¹

DETAILED

- Maximum climbing grade: 25%
- Maximum sustained climbing grade: 10%
- Maximum descent grade on non-rock surface: 35%
- Curve radius: 1.8 m minimum
- Usually associated with Trail Type III or IV

EXPECTED TECHNICAL TRAIL FEATURES

GENERAL

- TTF width to height ratio of 1:2
- Small bridges (flat, wide, low and rollable from section to section)
- Small rollable drops
- Small teeter-totters
- Small jumps
- Medium sized logs

DETAILED

- Embedded trail obstacles: up to 20 cm high
- Elevated bridges: less than 1.8 m (6') high above surface
 - Minimum width of flat decking is one-half the height above surface
 - For connected sections, the bisecting angle between each connected section must be large enough to allow the bicycle to complete transition without requiring any wheel lifting techniques
- Teeter-totter: maximum pivot height, less than 60 cm (2') high above the surface
 - Minimum width of flat decking is one-half the height above surface at pivot point
- Rock or ramp descents not to exceed 45%
- Drop-offs not exceeding 30 cm high with exit cleared of all obstacles
- Jumps
 - No jumps with consequences for lack of speed (for example, coffin jumps or gap jumps)
 - Table top jumps maximum height 60 cm (2')
 - Jumps maximum height 45 cm (18")



NAME: Most Difficult **SYMBOL:** Black Diamond

GENERAL

- A mixture of long steep climbs, loose trail surfaces, numerous difficult obstacles to avoid or jump over, drop-offs and sharp corners. Some sections are definitely easier to walk.¹²

DETAILED

- Maximum climbing grade: 30%
- Maximum sustained climbing grade: 15%
- Usually associated with Trail Type III, IV or V

EXPECTED TECHNICAL TRAIL FEATURES

GENERAL

- TTF width to height ratio of 1:4
- Elevated bridges and teeter-totters with maximum deck height
- Connected bridges
- Mandatory air
- Larger jumps
- Steep descents with sharp transitions

DETAILED

- Elevated bridges: less than 3 m (10')¹³ high above surface
 - Minimum width of flat decking is one-quarter the height above surface
- Teeter-totter: maximum pivot height less than 1.8 m (6') above surface
 - Minimum width of flat decking is one-quarter the height above surface at pivot point
- Mandatory air less than 1.0 m (3.3') vertical
- Rock or ramp descents not to exceed 120%
- Jumps
 - Table tops, no maximum height
 - No gap jumps or rhythm sections



NAME: Expert Unlimited **SYMBOL:** Double Black Diamond

GENERAL

- Exceptional bike control skills and balance essential to clear many challenging obstacles. High-risk level. Only a handful of riders will enjoy these rides.
- The RMOW recognizes Expert Unlimited as a difficulty level but due to the small size of the user group, the RMOW will not pursue ownership of these trails, however there may be some of these elements on a trail provided there is a clearly defined alternate route around.

DETAILED

- Similar to Most Difficult
- Usually associated with Trail Type III or IV

EXPECTED TECHNICAL TRAIL FEATURES

GENERAL

- Risk exceeds Most Difficult due to height, widths and exposure
- Fall zones may not meet fall zone standards
- The consequences of errors may be severe and rescue may be difficult

DETAILED

- Exceeding Most Difficult

⁹ Paul Kennett; Classic New Zealand Mountain Bike Rides; 1996

¹⁰ Paul Kennett

¹¹ Paul Kennett

¹² Paul Kennett

¹³ WCB requires "...that a fall protection system is used when work is being done at a place (a) from which a fall of 3m (10ft) or more may occur, or (b) where a fall from a lesser height involves an unusual risk of injury." Occupational Health & Safety Regulation Book 2, section 11.2, page 11-2

SUPPORTING GUIDELINES AND STANDARDS

This section is a microscopic view of trails. It contains guidelines and standards about the placement of trails, construction and strength of technical trail features and the signing of trails.

ENVIRONMENTAL GUIDELINES

The benefits of a trail for recreational purposes must be balanced with the desire to protect the environment. All intrusions into the environment have some degree of impact. However, these impacts can be minimized to balance the objective of a recreational experience with minimal impact on the surrounding environment. Trails that adversely impact the environment will deteriorate in time, have a low aesthetic value and incur a high maintenance cost. Trail construction must strive for minimal impact on their surroundings and be designed with consideration for the specific environment and the intended use of the trails.¹⁴

TRAIL PLACEMENT GUIDELINES

- Trail placement should avoid hazard areas such as unstable slopes, soil prone to erosion, cliffs, embankments and undercut stream banks, etc.
- Avoid shallow rooted trees with high windthrow potential and snags.
- Avoid routes that impact on wildlife species.
- Avoid critical habitat of rare or fragile plant species. If there are fragile plant communities next to the trail, delineate the trail edges by using logs or rocks.
- Avoid sensitive or fragile archaeological or historic sites.
- Avoid building trails in community watersheds.
- Avoid trail routing that encourages users to take shortcuts where an easier route or interesting feature is visible. If an interesting feature exists, locate the trail to provide the desired access to the trail user. Use landforms or vegetation to block potential shortcut routes.
- Avoid routing a trail too close to another trail section to prevent trail proliferation or shortcuts between the two trails.
- Route trailbeds on bedrock or hard packed surfaces and avoid organic materials.
- Use placed stones in sensitive areas and steep descents to minimize trail erosion.



DAVID DIPLOCK PHOTO

¹⁴ Sources for these classifications are: Ministry of Forest, Recreation Trail Management; Access Near Aquatic Areas, A Guide to Sensitive Planning, Design and Management, Province of BC.

AQUATIC ENVIRONMENTS

- Trail construction of Trail Types III-V near an aquatic area within 30 m of streams and within management zones as per Forest Practice Codes must minimize vegetation removal and soil disturbance. Construction standards should be consistent with trail use, thereby minimizing trail width requirements.
- Structures in direct contact with water should be inert (for example, natural untreated cedar, precast concrete or steel) to avoid water quality impacts associated with chemical leaching from treated wood. Pile supported structures are preferred over slabs or floats for bridges requiring supports in contact with streams.
- Locate bridge crossings to minimize disturbance to streambeds and banks. Sections of the waterway that are straight and where banks are stable are preferred for crossing.
- Construct bridges across streams to top-of-the-bank. This minimizes erosion of stream banks and sedimentation of streams.

GENERAL

- Avoid cutting down live trees.
- Tree branches must be cut at the collar, both longer or shorter are likely to cause infection to the tree (figure 1).¹⁵
- Cover exposed roots.
- If pretreated wood has been selected for structures being placed in the ground, the structure should be isolated in poly wrap below grade.

USE OF MACHINERY

- Limited access trails that penetrate sensitive areas should be constructed manually with materials and equipment that can be easily transported by small work crews.
- If machinery is required, minimum standards as per Forest Practices

Code should be adopted (i.e. no machinery within 5 m of any water-body.) Low impact construction techniques should be employed such as small underinflated, rubber tired vehicles, and construction pads, platforms or cranes. Prefabricated structures that can be manually assembled on site should be used, if possible.

FIGURE 1 BRANCH BARK RIDGE AND BRANCH COLLAR

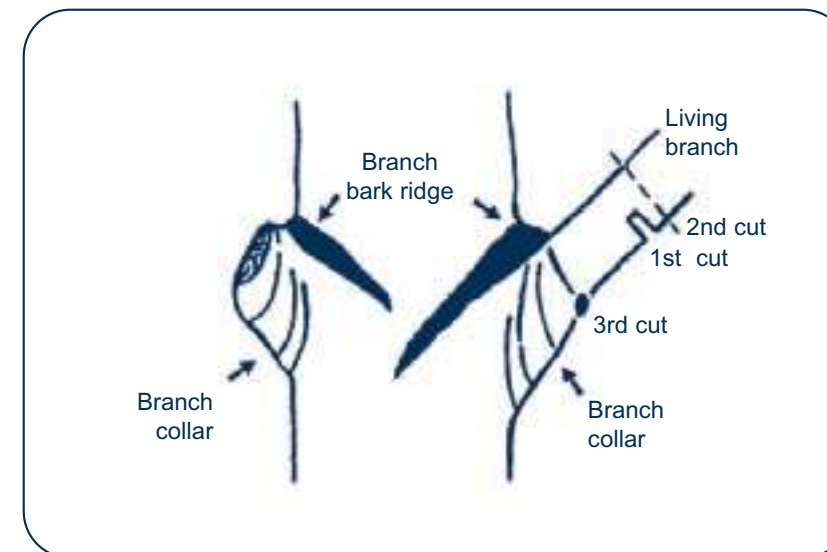

¹⁵ "Pruning Basics and Tools" [<http://www.ext.vt.edu/pubs/nursery/430-455/430-455.pdf>] (April 7, 2003)

TTF CONSTRUCTION STANDARDS

Trails with constructed Technical Trail Features (TTF) must exceed a minimum standard to protect the trail user.

SAFETY

TTFs must exceed the minimum strength and stability standard. Also, the finish must be such that if a rider were to fall, the structure or other protrusions would not increase the degree of the injury.

STRENGTH AND STABILITY

Each span of the TTF must be capable of withstanding a centered vertical load of 225 kg (495 lb, 2 times heaviest rider/bike and gear). Every single rung should be capable of holding a rider/bike and gear's weight.

TTF DESIGN PHILOSOPHY

- Gateways:
 - By placing a narrow section or difficult turn early while the TTF is still close to the ground (known as a gateway), inexperienced riders may dismount prior to the TTF getting too high above the ground where the rider is more likely to be injured should a fall occur. For example, place a 10 cm wide gateway 40 cm off the ground as a gateway to a 30 cm wide section 1.2 m off the ground.
- Make the highest difficulty section visible from the entry:
 - By placing the difficult section in view, the rider can make an informed decision before they may get into trouble with a TTF that may be beyond their ability.
 - Avoid wide, easy entrances leading to high, narrow exposed features

TTF HEIGHT AND WIDTH

As outlined in the Technical Trail Difficulty section, maximum height and minimum width are dependent on the TTFs difficulty. As the height above the ground increases, the consequence of injury in the case of a fall increases.

Height is measured vertically to the lowest point within 1.0 m adjacent to TTF (figure 2). Tread width is the amount of flat tread (figure 3).

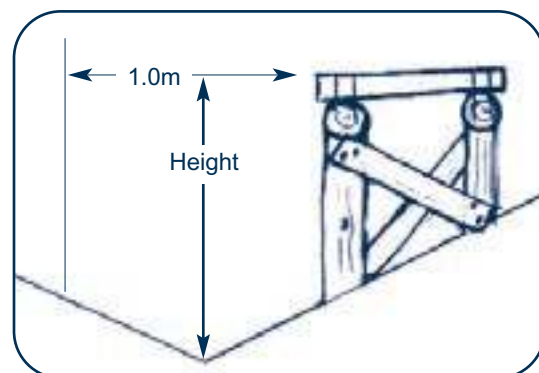

FIGURE 2 MEASUREMENT OF TTF HEIGHT

FIGURE 3
TREAD WIDTH
MEASUREMENT

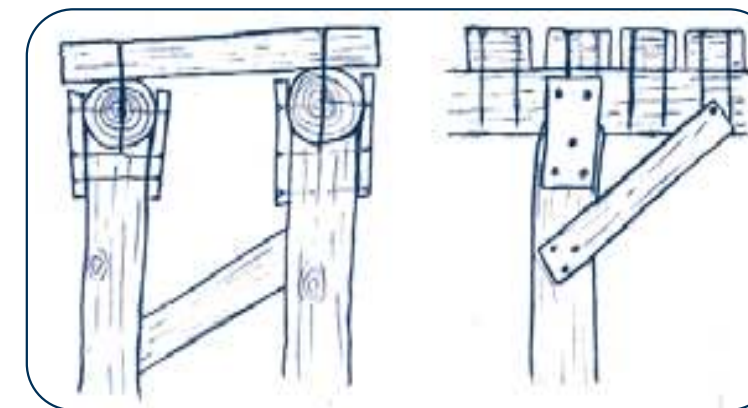
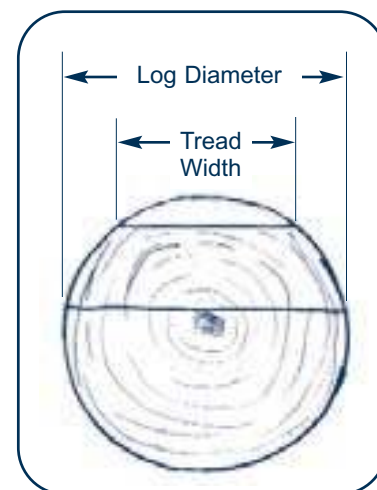

FIGURE 4 BRIDGE STRINGER SUPPORT AND CROSS BRACING

CONSTRUCTION PRACTICES

Cross bracing of vertical members is required (figure 4). Also, TTFs should not be mounted to living trees for the following reasons:

- The tree will continue to grow, compromising the integrity of the TTF.
- The tree may sway due to wind, weakening the TTF.
- Nailing to live trees is harmful to the tree.

CONNECTED MEMBERS

The methods for joining members in order of preference is: nuts and bolts, lag bolts, wood screws or ardox nails. Ensure two-thirds of nail or screw's length penetrates the stringer. Loading on a member should be done in such a way as not to rely exclusively on the shear strength of the joining method.

BRIDGE RUNG SPACING

Deck rungs must be placed tightly so that children will not catch their feet between rungs, arms will not fit between rungs and all users including dogs will use bridges as opposed to walking adjacent to the bridge, compromising the sensitive area the bridge was intended to protect. An appropriate spacing between rungs is 3 cm to promote drainage of water and mud. Overhang rungs past stringers by less than 5 cm (2 in) (figure 5).

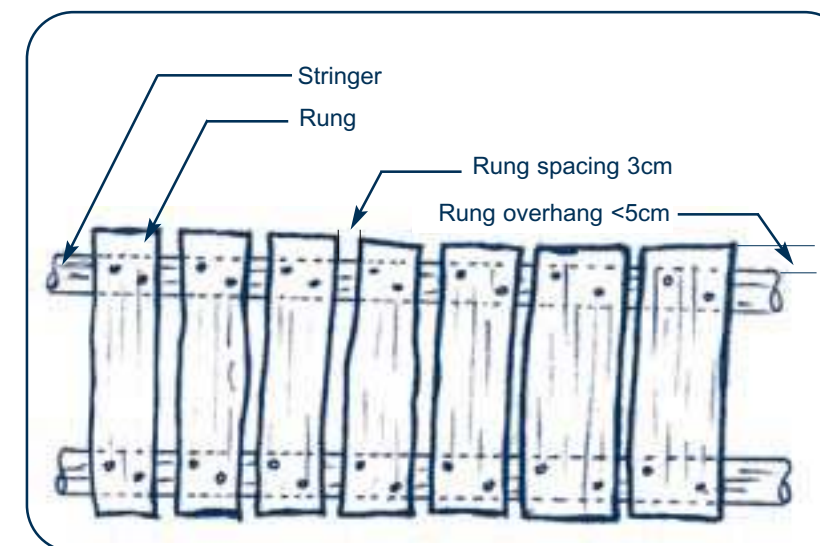

FIGURE 5 BRIDGE RUNG SPACING, RUNG OVERHANG

BRIDGE SURFACING

It is recommended that wood surfaces with a slope exceeding 10°, with the exception of split wood having a rough surface finish, have an applied anti-slip surface. One recommended material is expanded diamond lath. Chicken wire and rolled roofing material, although popular, are not durable and roofing material traps moisture promoting premature rotting.

Note: TTFs must be reinforced to withstand the additional loading of anti-slip surfaces against the direction of the braking forces.

WOOD PREPARATION

Bark must be stripped off and wood in contact with the earth should be isolated to minimize rotting. For natural rot resistant wood, use cedar.

FALL ZONE GUIDELINES

Riding a mountain bike on trails and technical trail features involves challenging oneself and with that challenge comes risk of injury. Challenges come from terrain that contains many natural and man made features. Risk is relative to riders skill level in relation to the difficulty of the trail.

FALL ZONE

The fall zone is the area adjacent to the technical trail feature, bottom of descents and the outside of corners that the rider may deviate into. To help reduce the incidence and severity of injuries, fall zones should be reviewed for hazards. Hazard mitigation efforts can be limited to those items that can be reasonably expected to be reshaped or removed using hand tools while maintaining the natural characteristics of the terrain surrounding the trail.

METHODS

Methods to reduce risk in fall zones (1.5 m to each side of the trail) include but are not limited to:

- Cutting or digging out any sharp objects
- Trimming tree branches to branch shoulder (see figure 1)
- Covering of hazards is another option if material such as rotten logs, bark, mulch, dirt, etc. is available
 - Areas where falls are frequent may need periodic re-covering
- Dulling of sharp points or edges of exposed rocks

NOTE The fall zone need not be cleared of all foliage; the purpose of fall zone guidelines is to reduce the chance of injury should a fall occur. Replanting of the fall zone with a durable locally occurring species may be considered.

FOCUS

The primary focus for fall zone clearing should be on trails rated 'More Difficult'. Riders may be learning to ride TTFs and their fall recovery may not be perfected.



BONNIE MAKAREWICZ PHOTO

SIGN GUIDELINES

Signs are a necessary component of trail management. They provide the user with information that will allow them to make an informed and educated choice. The hierarchy of signs in Whistler will be comprised of three levels. The first is a Trail Network Sign kiosk that contains a map, general information about the area and safety suggestions. The second level is a Trailhead Sign that would contain information specific to the trail. Third, En Route Signs along the trail to promote confidence in the user that they are following the correct route and to be posted on features that are a higher difficult rating than the trail rating.

TRAIL NETWORK SIGN

Located at a parking lot or similar entrance to a network of trails. Information for trail network signs may contain a combination of the following:

- Topographical map of area
- IMBA rules of the trail
 1. Ride on open trails only
 2. Leave no trace
 3. Control your bicycle
 4. Always yield trail
 5. Never spook animals
 6. Plan ahead
- Trail etiquette
 1. Stay on trail, no ride-a-rounds
 2. Do not alter trail
 3. Ride don't slide
 4. Avoid riding in muddy conditions
 5. Know your limits
 6. Support trail maintenance
- Safety
 1. Ride in 3's
 2. Carry a flashlight
 3. Carry a foil emergency blanket
 4. Let someone know your route, time of return and carry a two-way communication device.
 5. Wear a helmet
- Notes about keeping dogs out of fish bearing streams and educational components
- Information on who to contact with trail maintenance concerns or how to get involved
- Acceptable trail user groups
- Emergency contact phone numbers
- Description of cell phone coverage
- Background information on the surrounding area and trails
- Trail maps for distribution
- Bulletin board
- Reference to web or other resource

TRAILHEAD SIGN

These signs are to be located at the entrance(s) of a particular trail to provide the user with the information necessary to make an informed and educated decision whether to proceed or not.

SUGGESTED INFORMATION

- Trail name
- Topographical map of trail
- Trail length
- Elevation gain and loss
- Use at own risk disclaimer

DETAILS

Sign size 140 mm X 370 mm. Selected to be mounted without overhang on 150 mm X 150 mm posts (figure 6).

OPTIONAL INFORMATION

- Trail difficulty rating and a written explanation of what the user may encounter on the trail
- Warning and quantity of higher difficulty TTFs if present
- Conditions subject to change
- Inspect TTFs prior to riding
- Time range to complete
- Trail profile
- Disclaimer – most trails will be a level or two harder to ride when slippery

MANAGEMENT GUIDELINES

EN ROUTE SIGN

Located along the trail indicating to the user they are still on the desired trail and/or give warning of the higher difficulty of an upcoming TTF. En route signs express difficulty in three ways: shape of sign, color of sign and trail profile symbol on the sign. The signs are labeled with the trail name to distinguish between different trails.

- En route signs to be placed at junctions with alternate trails giving clear indication of each trails' direction. Use difficulty symbol and trail name with a reflective white border.
- For TTFs rated a higher difficulty than the trail rating, en route signs to be posted as warning. Use difficulty symbol and trail name with a reflective yellow border. If feature can not be safely walked, an easier signed bypass route must be provided (figure 6).
- If appropriate, signs may be placed at intervals to guide user.
- Consider reflective signs for night use.

DETAILS

For en route signs marking higher difficulty features, it is important for the sign to be highly visible. Place sign approximately 1.0-1.5 m above tread.

FIGURE 6 TRAILHEAD & EN ROUTE SIGNS

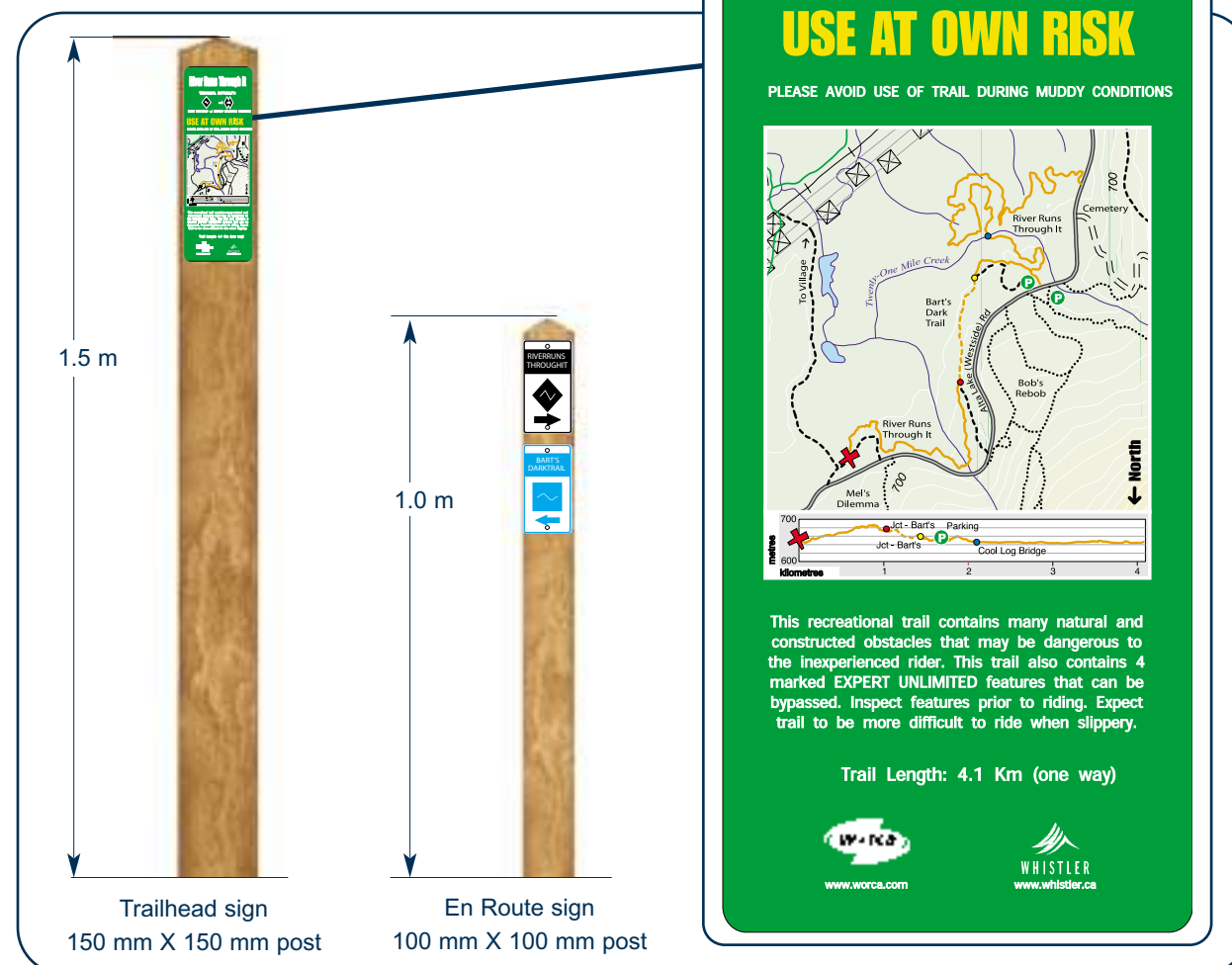

CONSTRUCTION

For new trails, the RMOW will use an experienced trail builder for the trail alignment and follow the supporting guidelines and standards.

TRAIL RATING

The trail and each feature along the trail is reviewed and measured to determine its difficulty. The details and difficulty level of each feature need to be recorded. The trail may be rated as low as the average feature difficulty or as high as the highest feature's difficulty, bearing in mind all features rated at a higher difficulty than the trail's rating must be individually signed. If the feature can not be safely walked, the feature must have an easier, signed bypass route. The trailhead sign must also inform the user that there are higher difficulty features.

TRAIL MAINTENANCE

Trail maintenance is an integral part of managing trails. In general, high use trails and trails in environmentally sensitive areas require a greater level of maintenance and an expedited response to trail deterioration. Trails with man-made TTFs also require more frequent inspection.

MAINTENANCE PRIORITIES

The RMOW will inspect municipal trails as follows:

- **HIGH PRIORITY TRAILS** will be inspected twice a year (April and July). These include all Type I trails, all trails in PAN 1 environments and trails with known constructed TTFs.
- **MEDIUM PRIORITY TRAILS** will be inspected in the spring of each year or prior to the start of the trail use season. These include all trails in PAN 2 and PAN 3 environments and all Type II trails.
- **LOW PRIORITY TRAILS** will be inspected in the spring of each year or prior to the start of the trail use season. These include all remaining mountain bike trails.

All inspections and maintenance must be documented.

INSPECTION TO INCLUDE

Review of the trail;

- for safety;
- to verify difficulty designation.

Review of signs;

- for presence and condition.

Review of constructed features;

- for structural integrity.

TERMINOLOGY

MAINTENANCE TRIGGERS

Triggers for trails requiring additional maintenance:

- TTFs deteriorating.
- Short-cutting of climbing turns and/or switchbacks.
- Trail drifting or sliding down the hill.
- Vegetation cover loss.
- Trail proliferation (widening or braiding).
- Trail incision and soil loss (ruts exceeding 15 cm depth).

GRANDFATHER CLAUSE

In the case of valued existing trails in protected areas when trail deactivation is unlikely to succeed, trail management becomes the preferred option. When considering the Grandfather Clause as an option, evaluate the continuing cost of maintenance to manage the trail. A trail deactivation/closure may not be successful if the trail has been established, is well used, and no alternative route is proposed. The resulting damage may be worse than had the trail remained open and effectively managed.

TRAIL DEACTIVATION

There may be a number of reasons for deactivating an existing trail. When considering deactivation of a trail, take into account;

- Is the trail popular?
- Is the level of impact acceptable or can it be made acceptable by management?
- Can the trail or part of the trail be rerouted to improve the situation?
- Are there suitable alternatives for users if the trail was deactivated?
- Is the trail historically significant?

Alternates to trail deactivation:

- Management of trail use.
 - Temporary closures
 - Reroute sections of trail
 - Exclusion of damaging users
- Education of users with signs or other education initiatives.

When considering deactivation of trails, steps must include the following:

- Consult user groups.
- Public notice.
- Monitoring to ensure trail remains deactivated.

And may include:

- Signs informing users of reasons for closure.
- Fences.



BONNIE MAKAREWICZ PHOTO

A-FRAME – two ramps (approach and exit) placed together with no level section at the apex. Typically used to bridge deadfall across the trail.

BERM – built up bank on the outside of a corner to improve cornering.

BOARDWALK – a raised walkway made of boards; used to traverse sensitive areas; similar to bridge.

BRIDGE – a structure that is built above and across a river or other obstacle allowing passage across or over obstacle.

DANGER – likely to cause harm or result in injury.

DROP-OFF – a drop in the trail, possibly at the end of a log or off a rock; may require a technique depending on the vertical drop and/or the angle of descent.

EN ROUTE – on the way.

EXPOSURE – placing a rider in the position or location that an error in balance or maneuvering may result in an injury; for example, a narrow bridge above rocks would be exposure and the greater the elevation of the bridge above the rocks, the greater the level of exposure.

FACE – the steep exposed side of a rock.

FALL-AWAY – a drop-off which incorporates a turn in the trail.

GAP JUMP – two ramps placed back to back with a space between them, the rider must travel with enough velocity to cross the space and land on the second ramp.

GATEWAY – a qualifier placed before a trail or TTF; for example, a 2x4 placed before an elevated bridge or a difficult corner. If the rider can successfully negotiate the more difficult gateway, then they will likely be able to negotiate the TTF.

GRANDFATHER CLAUSE – provision exempting certain pre-existing trails from the requirements of a new regulation.

JUMP – a wedge shaped feature built with the intention of sending the rider airborne.

LADDER – a TTF with rungs attached to sides (stringers) made of metal, wood or rope, used for climbing up or down.

LOGJAM – a pile of logs placed near perpendicular to trail to make a ramp, usually placed in front of and behind deadfall to ease passage.

MACHINE BUILT – constructed with the use of an excavator.

MANDATORY AIR – a TTF requiring a wheelie drop or other advanced technique to exit due to a steep or undercut exit.

MANUAL – technique used to lift the front end of a bike up without the use of a pedal stroke; can be used off mandatory airs, etc.; generally requires more forward momentum than a wheelie drop.

PAN – Protected Area Network, sometimes know worldwide as greenways, environmental corridors, landscape linkages, wildlife corridors or riparian buffers.

RAMP – any inclined structure, typically used as an approach to or exit from a TTF. A ramp can also be a jump.

RHYTHM SECTION – series of gap jumps placed end to end. Most technical form of jumping due to skill, timing, technique and failure consequence.

RIPARIAN ZONE/AREA – land between the water and the high water mark on the riverbanks. Riparian areas typically exemplify a rich and diverse vegetative mosaic reflecting the influence of water.

ROLLABLE – a section that can be ridden without requiring higher-level rider skills; for example, an elevated bridge intersection/corner that can be ridden without having to hop and rotate.

ROLL OVER – usually a rock that gets steeper the farther the rider advances, to the point where stopping may not be an option and the rider must continue despite not being prepared for what's ahead.

TABLETOP – two jumps back to back with the void between the jumps filled in with dirt, creating the tabletop.

TEETER-TOTTER – a TTF consisting of a long plank balanced on a central support for riders to cross over, providing an down motion as the rider passes over the pivot.

TONGUE – a steep ramp on the exit of a TTF, often as an easier alternative to mandatory air.

TOP-OF-THE-BANK – the highest elevation of land, which confines to their channel waters flowing in an intermittent or perennial stream or river.

TREAD – the traveled surface of the trail.

TTF – Technical Trail Feature – an obstacle on the trail requiring negotiation, the feature can be either man made or natural, such as an elevated bridge or a rock face respectively.

WHEELIE DROP – technique used to pedal off drops-off or logs with the back wheel landing before the front wheel.

NOTES